

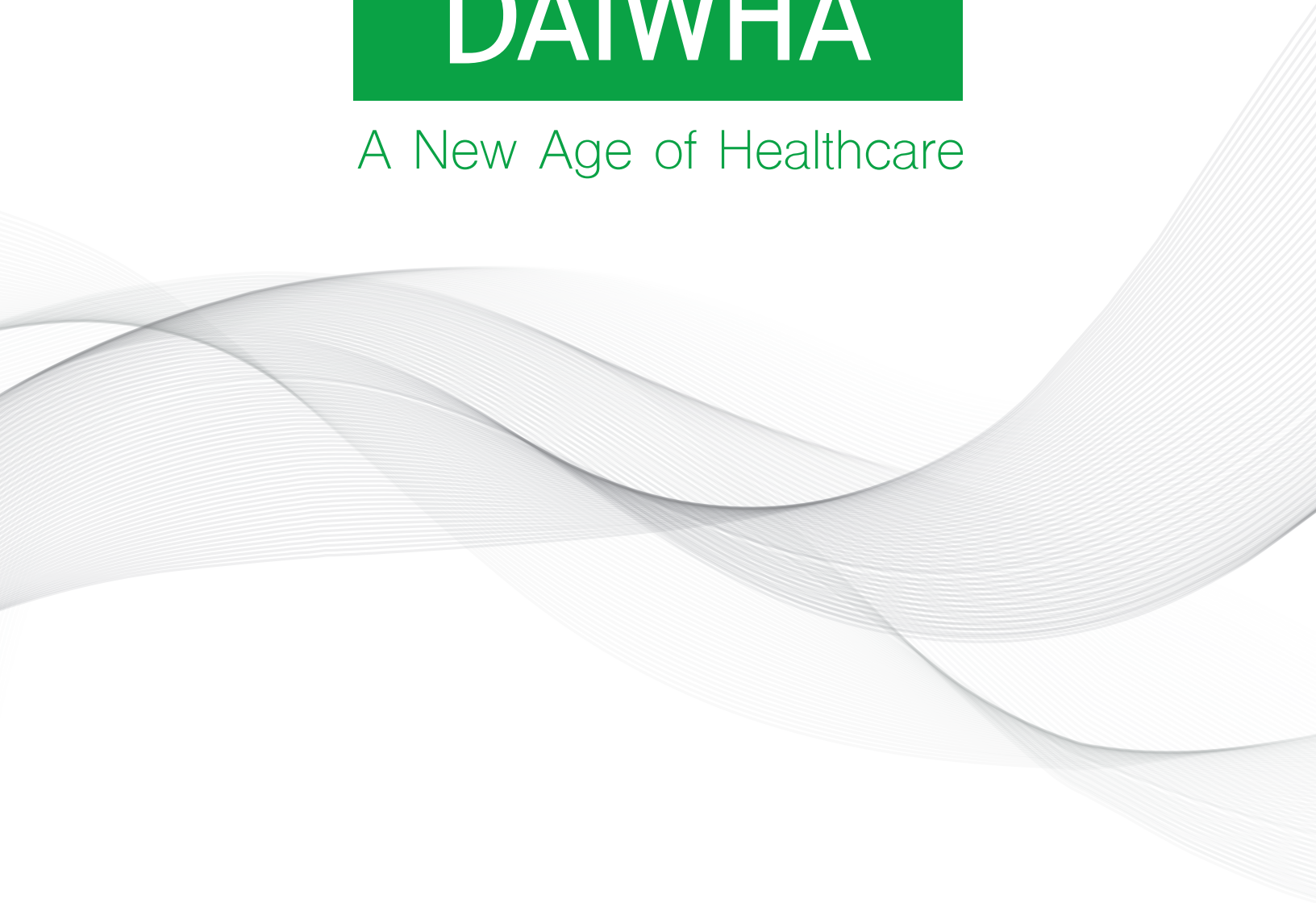

A New Age of Healthcare



Since 1979

Electro Surgical Unit
Infusion Pump

HQ in Seoul
Factory in Wonju

Transparent
Ethical
Professional
Customer Satisfaction



Since 1979, Daiwha Corp. Ltd. has been a leader in the manufacturing and distribution of medical devices, Electro Surgical Unit and Infusion Pump.

In 2009 we enlarged our R&D center at our headquarters in Seoul and rebuilt our factory within DongWha Medical Device Complex in Wonju City. Through continuous internal R&D investments we have successfully stayed true to our core values while expanding into the competitive global market.

Using our company's philosophy for transparent, ethical, and professional management along with our social contribution mindset, our employees set the standard for excellence in customer satisfaction.

INFUSION SYSTEM
MEDIFUSION®

05 DI-2X00 Series
06 DI-4000 I DS-3000
07 DI-6000 I DS-5000
08 Coming-Up Next
DI-6X00V Series

09 IV Set I Drop Sensor

ESU
MEDITOM®

10 DT-150S/200S
10 DT-300S/400S
11 DE-400
12 New Product
DUB-100

13 ESU Accessories

DI-2000



DI-2200



DI-2000EN



DI-2000A



DI-4000



DS-3000



DI-6000



DS-5000



DI-6000V/6200V



IV SET

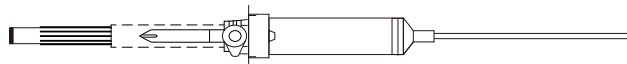

DROP SENSOR

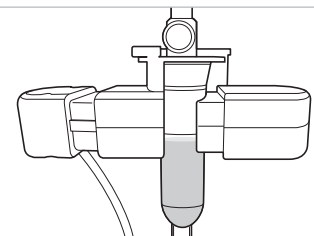

DT-400S/300S



DT-200S/150S



DE-400



DUB-100



COMING
UP NEXT

DU-137/127/115

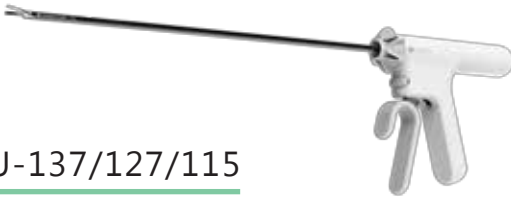

DU-SCISSORS



DU-137P/127P/115P

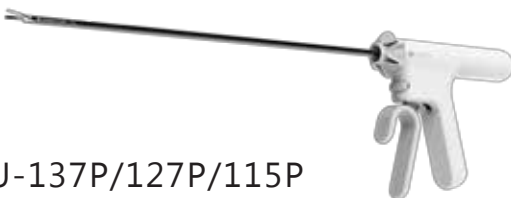

DB-137



VOLUMETRIC INFUSION PUMP /
DI-2000 | 2200 / MEDIFUSION®



Single & Dual Channel of Compact Design
Double Door Lock System for Free Drop Protection
IV Set Library : Compatibility with Other Brands
Event History Monitoring System
Various Setting Modes

ENTERAL NUTRITION | VOLUMETRIC INFUSION PUMP
DI-2000EN | 2000A / MEDIFUSION®



REFURB
AVAILABLE

- Compact Design & Easy Portable
- Double Door Lock System for Free Drop Protection
- Feeding | IV Set Library : Compatibility with Other Brands
- Event History Monitoring System
- Various Setting Modes

VOLUMETRIC INFUSION | SYRINGE PUMP
DI-4000 | DS-3000 / MEDIFUSION®

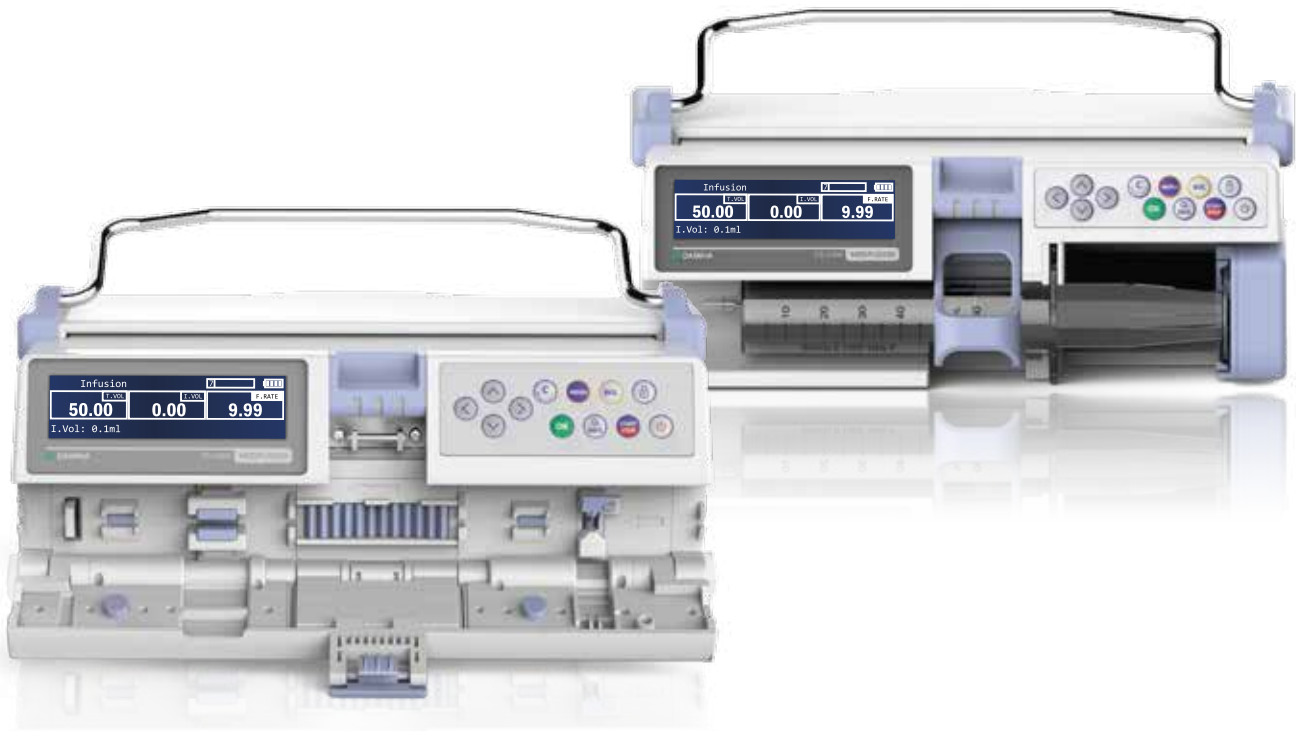

Advanced Technology Infusion System
Flexible Structure : Customized Station System
Secondary Infusion Mode | Relay Infusion Mode
Various Language Configuration
Event History Monitoring System

VOLUMETRIC INFUSION | SYRINGE PUMP
DI-6000 | DS-5000 / MEDIFUSION®



Premium Line Advanced Technology Infusion System
Ergonomic Design with Compact Body Size
High Convenience TFT-LCD & Jog Dial
Secondary Infusion Mode | Relay Infusion Mode
Docking Station System with CMS

VOLUMETRIC INFUSION PUMP
DI-6000V | 6200V / MEDIFUSION®

PREMIUM



Single & Dual Channel of Compact Design
Double Door Lock System for Free Drop Protection
IV Set Library : Compatibility with Other Brands
Event History | Central Monitoring System (Wireless)
Various Setting Modes

▶ DAIWHA INFUSION SETS

General IV Set(Standard) DIS-100 | General IV Set(Needleless) | Lightproof IV Set DIS-101

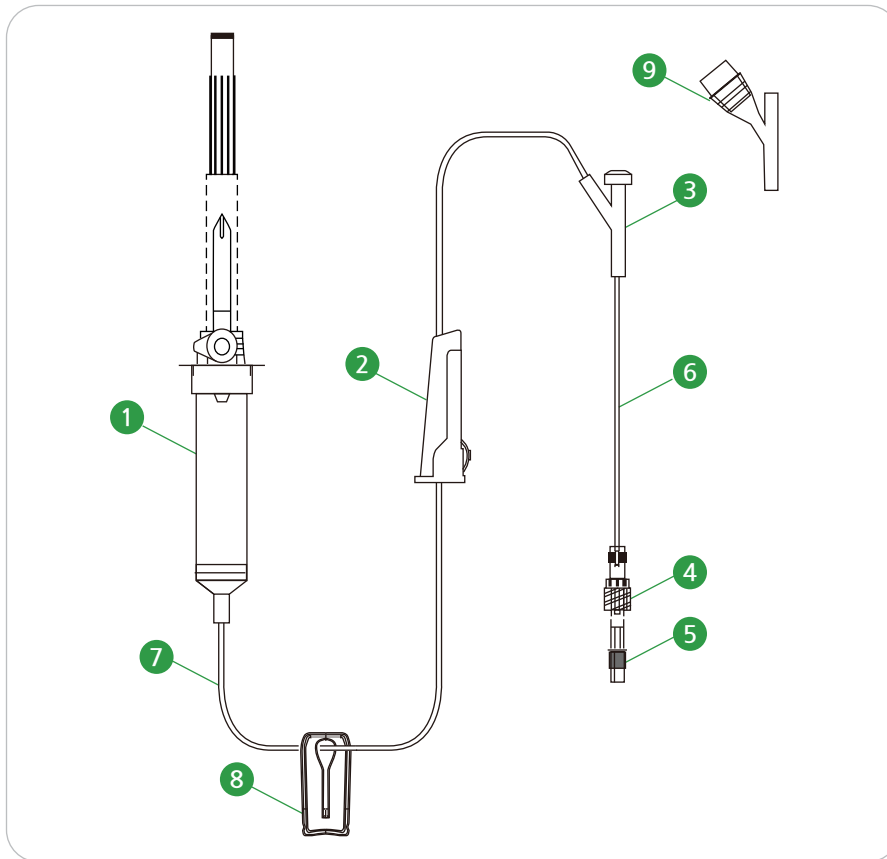

▶ DIS-100

1. Chamber
15um liquid medicine filter
2. Regulator
3. Up to 3 Y-injection available
4. Detachable Luer Lock tip
5. Detachable Luer Lock tip
With a liquid stop filter
6. Elastic Tube length 30cm
Standard / Light-Proof
7. Elastic Tube length 220cm
Standard / Light-Proof
8. Clip for DAIWHA Infusion Pump

▶ DIS-100 (Needleless)

9. Needleless-type available
(Replacing #3 to another type
of Y-injection)

▶ DIS-101

Lightproof IV Set
with UV coated in brown

▶ DROP SENSOR

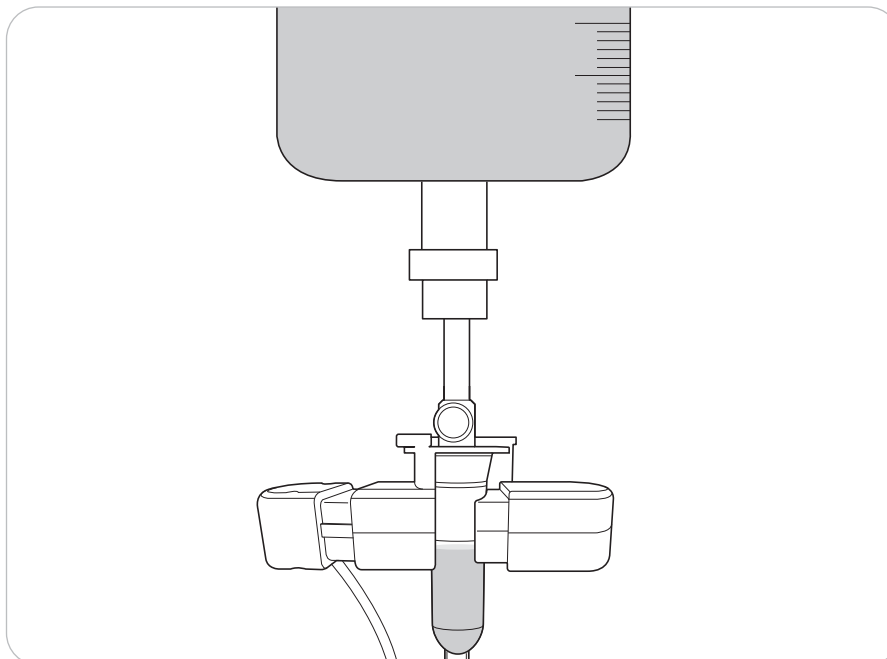

1. Detects free flow caused by
abrupt device malfunctioning
2. Detects No Drop caused by
an empty bottle or clogging of
the tube.

ELECTRO SURGICAL UNIT

DT-400S | 300S / DT-200S | 150S / **MEDITOM®**



Practical and Convenient Interface
Various Operation Modes
Safety Function D.R.M System
Automatic Patient Return Monitoring
User Memory Function

ELECTRO SURGICAL UNIT /
DE-400 MEDITOM®



- New Digital Technology
- Safety Function D.R.M System
- Daiwha APC Function (Auto Power Control)
- Various Operation Modes
- Automatic Patient Return Monitoring

ELECTRO SURGICAL UNIT
DUB-100 / MEDITOM®

PREMIUM



New Digital Technology
Laparoscopic Energy System
Daiwha APC Function (Auto Power Control)
Various Operation Modes
Automatic Patient Return Monitoring

▶ LAPAROSCOPIC ENERGY DEVICES

▶ MEDISONIC® DU-137/127/115

[Ultrasonic]

Working with DUB-100

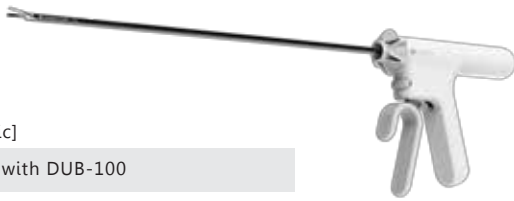

▶ MEDISONIC® DU-SCISSORS

[Ultrasonic]

Working with DUB-100



▶ MEDISONIC® DU-137P/12P7/115P

[Ultrasonic+Bipolar]

Working with DUB-100



▶ MEDIPOlar® DB-137

[Bipolar+Blade]

Working with DUB-100 | DE-400

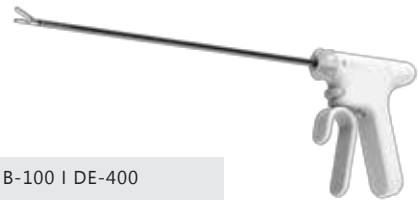

▶ MEDITOM STANDARD ACCESSORIES

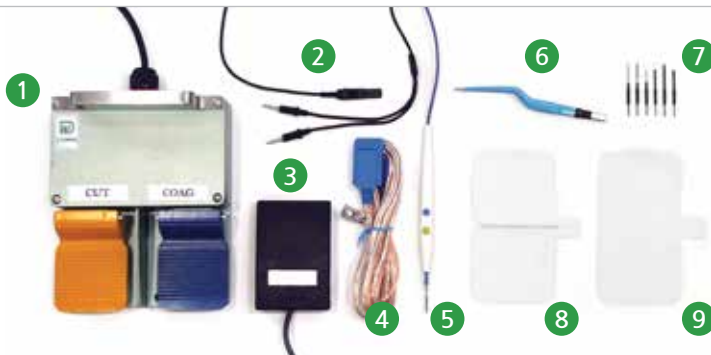

▶ DT-400S/300S | DE-400

1. Double Footswitch
2. Reusable Bipolar Forceps Cable
3. Single Footswitch
4. Reusable Plate Cable
5. Disposable Twin Button Handle with Cable (2pcs/1pc for DT-200S/150S)
6. Bipolar Forceps (310-160, 1mm, Bayonet Sharp)
7. Electrodes (6pcs)
8. Disposable Dual Plate (5pcs)
9. Disposable Single Plate (5pcs)

* DT-200S/150S Accessories are the same as above without green text items(#2,3,6).

▶ OPTIONAL ACCESSORIES



1. 310-130 (1mm, 2mm) Straight Sharp
2. 310-132 (1mm, 2mm) Straight Angled
3. 310-160 (1mm, 2mm) Bayonet Sharp
4. 310-162 (1mm, 2mm) Bayonet Angled Up
5. 310-165 (1mm, 2mm) Bayonet Angled Down
6. 310-102 (0.5mm) Straight Angled
7. 310-100 (0.5mm) Straight Sharp



1. Reusable Rubber Plate with Cable
2. Disposable Single Plate (5pcs)
3. Conization Square Electrode (from left to right)
3. Conization Round Electrode
3. Conization Diamond / Triangle Electrode
4. Disposable Twin Button Handle with Cable
5. Double Foot Switch (FS82)



DAIWHA

