

# SY02-LED3E (on stand)

## Emergency Shadowless Operating lamp



ISO9001:2008



ISO13485:2003



- Uniform, homogeneous lighting in surface and deep cavity procedures thanks to SY02-LED's innovative shadow control.
- Our ergonomic, sterile operating concept allows for the simple and flexible control of all functions by the surgical team.
- Almost unlimited LED life expectancy delivers tremendous product reliability and investment protection.
- Environmentally proactive: low power consumption and durable LEDs minimize the impact on our precious resources.

### Technical Data

Illuminance:	$\geq 130,000\text{Lux}$
Colour temperature:	$4500 \pm 200\text{K}$
Colour reduction index (Ra):	96
Illuminance depth:	1020mm
Power supply voltage:	AC110-240v, 50/60Hz
Rated power of bulb:	3.2V/1W
Total irradiance:	$380\text{W/m}^2$
Size of light field:	200~350mm
Service life of illuminant:	50,000h
Total power consumption:	70W
Total LED bulb quantity:	110 pcs
Emergency time:	3hours



SHANGHAI HUIFENG MEDICAL INSTRUMENT CO., LTD

ADD: NO.7753, Chuannanfeng Highroad, Datuan Town,  
Pudong District, Shanghai, China.

Tel: +86-21-58084992 Fax: +86-21-58085105



## OPTIMIZED AIR FLOW DESIGN FOR BETTER HYGIENE

With its open design and superior ventilated ceiling tolerance, SY02-LED ensures that perfect operating conditions are created and hygienic requirements are fulfilled. The airflow surface under the ventilated ceiling is minimized and the reduced heat generation ensures a low turbulence displacement stream under the light head.



## LONG LIFE LIGHTING

LED light source life of up to 50,000 hours or more, with an average life of an ordinary light shadowless lamp halogen 30 times, and each LED can be individually replaced, to ensure maximum use of economy.

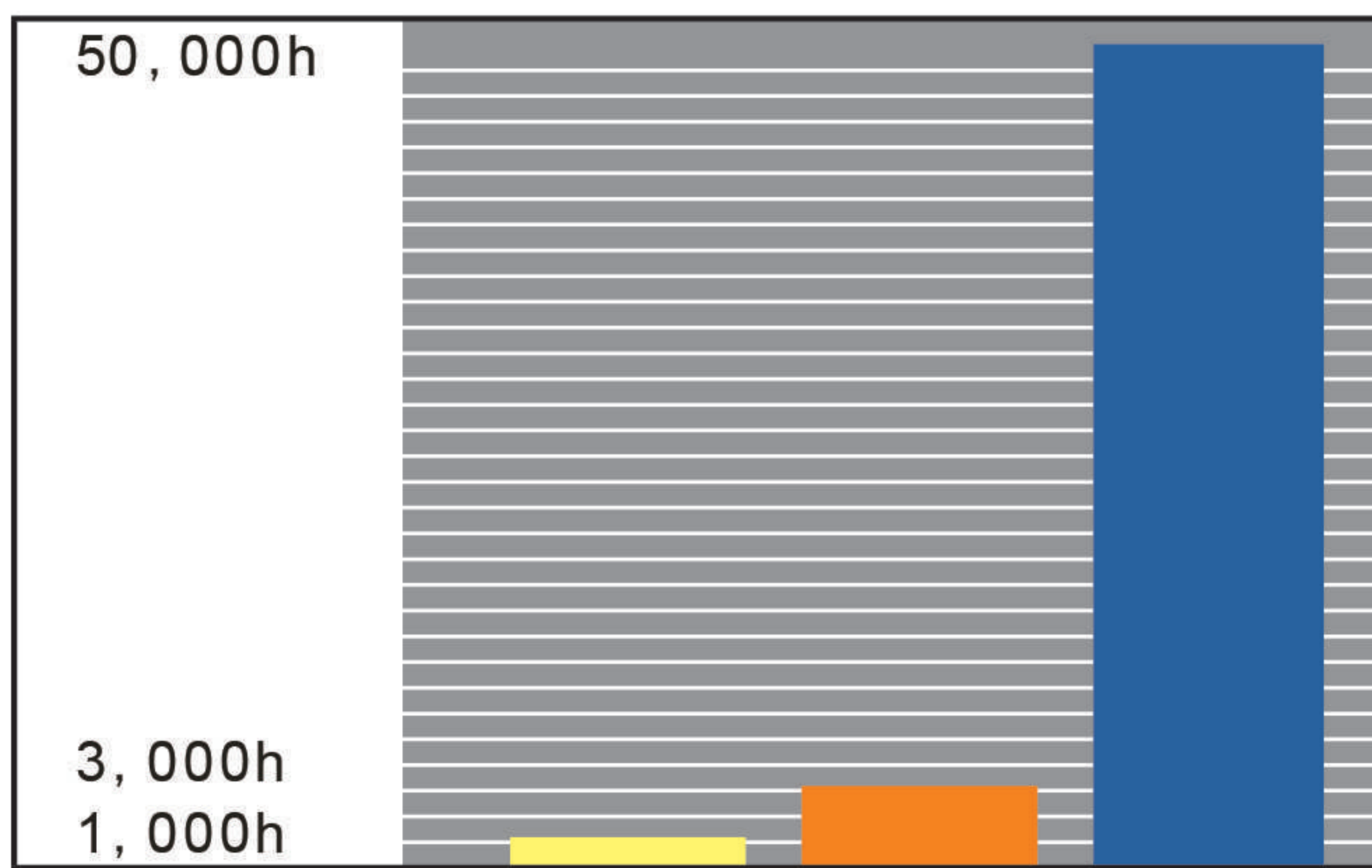

Halogen bulb

Gas light bulb

High-performance LED light source

## INSTALLATION DIAGRAM

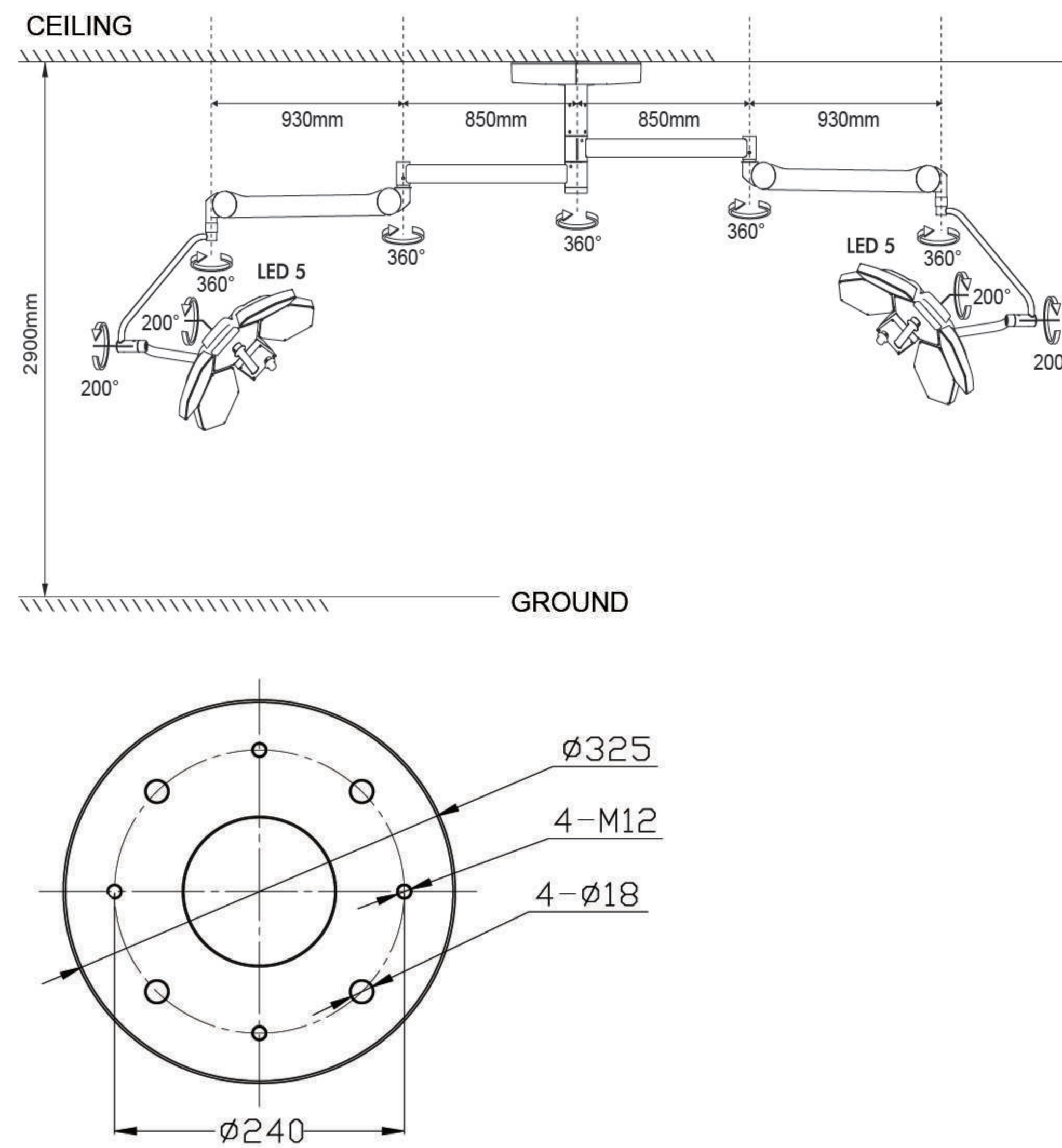

The attentions to install fixed plate:

The ceiling must be able to load 500kg weight.

If the height of ceiling is more than 3.2m, you must fix a extension frame. (You may order from our factory.)

User's ground wire should reliably connect with product's ground terminal(yellow green line).

The ceiling mounted shadowless operating lamp is belong to heavy pensile product, its safe service period is 10 years.

If the product has any change, subject to change without prior notice.

(Apply to various kind of ceiling mounted operating lamp.)

**SHANGHAI HUIFENG MEDICAL INSTRUMENT CO.,LTD.**

Add:No.7753,Chuannanfeng Highroad,Datuan Town,Pudong New District,Shanghai Zip:201311

Sales department

Tel:0086-21-58082099、58084992、58085105、58086595

Fax:0086-21-58085105

Http://www.huifeng-co.com



ISO9001:2008 ISO13485:2003



# SY02-LED5+5

## SHADOWLESS OPERATING LAMP

ADJUST COLOR TEMPERATURE





## UNMATCHED SHADOW MANAGEMENT OPTIMIZES CONCENTRATION AND SURGICAL TEAM EFFICIENCY

Huifeng has harnessed the far-reaching potential of the multi-lens matrix to virtually eliminate shadows. The SY02 series's overlapping fields of light and multiple patterns - selectable based on the surgical situation - minimize shadows and redirect the full selected intensity to the surgical site. The result is up to 20% more light in deep cavity situations.

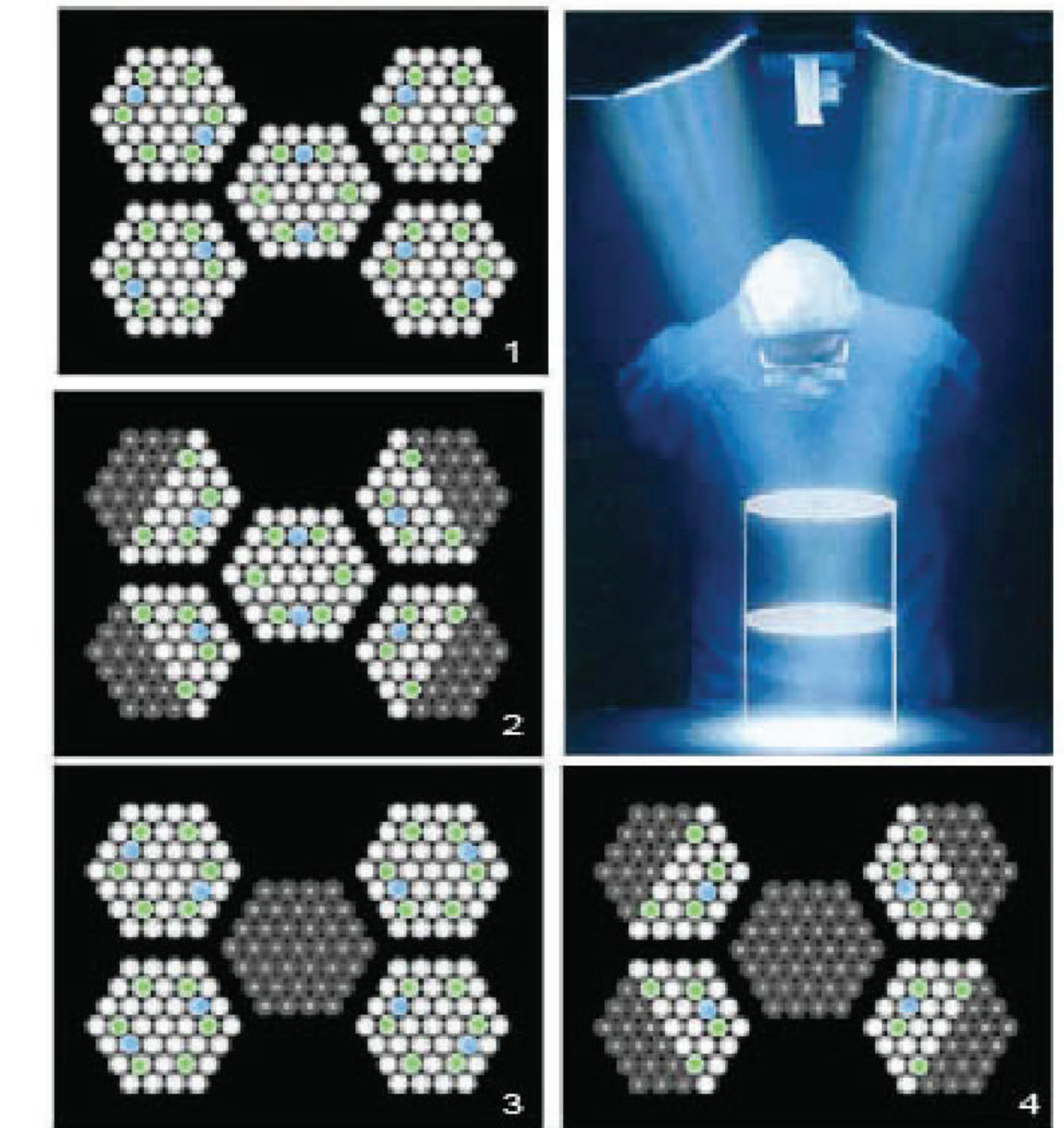

**ADJUST COLOR TEMPERATURE**  
**3500K 4000K 4500K 5000K**

## STERILE CONTROL OPERATIONS

- One of the innovative characteristics of SY02 series: the sterile control concept enables the surgical team to operate all important functions intuitively, quickly and simply.
- On and off-switch
- Shadow management

## SY02-LED SERIES LEADING-EDGE LIGHTING TECHNOLOGY

Thanks to their great performance and outstanding energy efficiency, the use of LEDs to illuminate demanding environments is becoming ever more common. Compared to conventional lamps, light emitting diodes have a whole range of technological, economic and ecological advantages: low heat generation, minimal power consumption and an almost unlimited life expectancy. SY02-LED combines these characteristics. The result: unparalleled performance.

- **Precise**  
Uniform, homogeneous lighting in surface and deep cavity procedures thanks to SY02-LED's innovative shadow control.
- **Simple**  
Our ergonomic, sterile operating concept allows for the simple and flexible control of all functions by the surgical team.
- **Durable**  
Almost unlimited LED life expectancy delivers tremendous product reliability and investment protection.
- **Efficient**  
Environmentally proactive: low power consumption and durable LEDs minimize the impact on our precious resources.

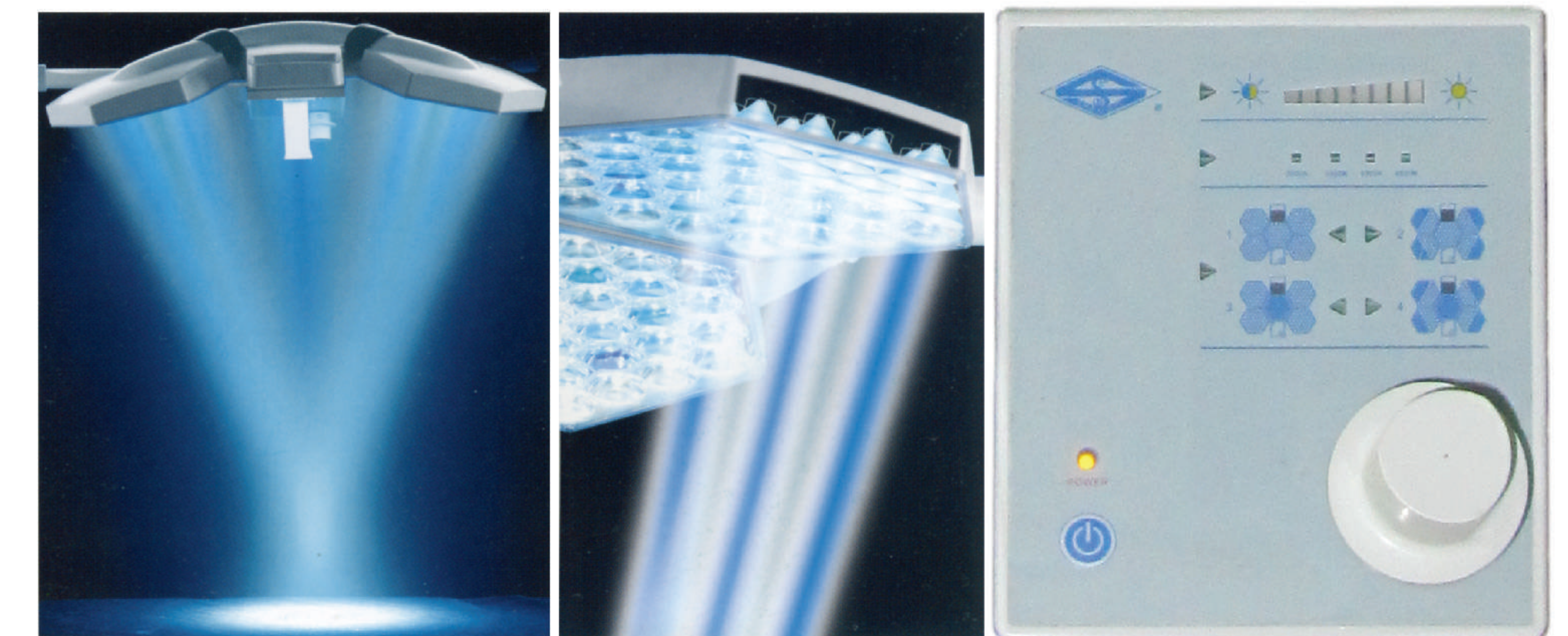

Technical Data	SY02-LED5+5
Central illuminance	160.000 Lux
Size of light field	200 - 350 mm
Colour temperature	3500K/4000K/4500K/5000K
Color reduction index	96
Service life of illuminant	50.000 h
Total irradiance	510W/m <sup>2</sup>



# SY02-LED5+5



## SHADOWLESS OPERATING LAMP

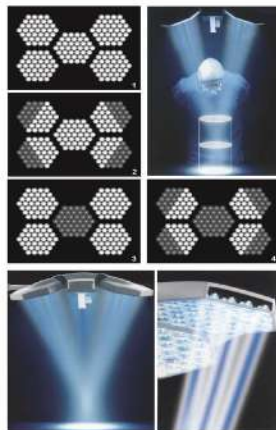

### UNMATCHED SHADOW MANAGEMENT OPTIMIZES CONCENTRATION AND SURGICAL TEAM EFFICIENCY

Huifeng has harnessed the far-reaching potential of the multi-lens matrix to virtually eliminate shadows. The SY02 series's overlapping fields of light and multiple patterns - selectable based on the surgical situation - minimize shadows and redirect the full selected intensity to the surgical site.

The result is up to 20% more light in deep cavity situations.

### STERILE CONTROL OPERATIONS

- One of the innovative characteristics of SY02 series: the sterile control concept enables the surgical team to operate all important functions intuitively, quickly and simply.
- On and off-switch
- Shadow management

Technical Data	SY02-LED5+5
Central illuminance	160.000 Lux
Size of light field	200 - 350 mm
Colour temperature	4500K
Color reduction index	96
Service life of illuminant	50.000 h
Total irradiance	510W/m <sup>2</sup>

## OPTIMIZED AIR FLOW DESIGN FOR BETTER HYGIENE

With its open design and superior ventilated ceiling tolerance, SY02-LED ensures that perfect operating conditions are created and hygienic requirements are fulfilled. The airflow surface under the ventilated ceiling is minimized and the reduced heat generation ensures a low turbulence displacement stream under the light head.



## LONG LIFE LIGHTING

LED light source life of up to 50,000 hours or more, with an average life of an ordinary light shadowless lamp halogen 30 times, and each LED can be individually replaced, to ensure maximum use of economy.

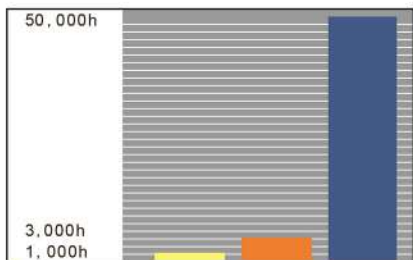

Halogen bulb

Gas light bulb

High-performance LED light source

## INSTALLATION DIAGRAM

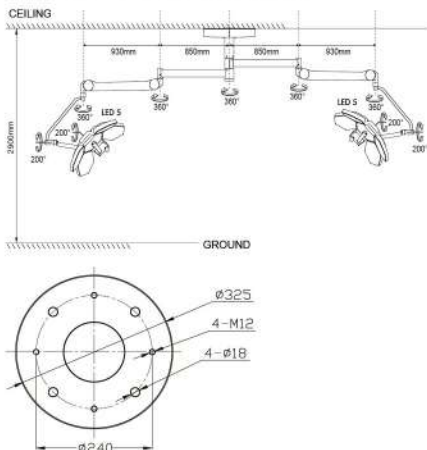

The attentions to install fixed plate:

The ceiling must be able to load 500kg weight.

If the height of ceiling is more than 3.2m, you must fix an extension frame. (You may order from our factory.)

User's ground wire should reliably connect with product's ground terminal(yellow green line).

The ceiling mounted shadowless operating lamp is belong to heavy pensile product, its safe service period is 10 years.

If the product has any change, subject to change without prior notice.

(Apply to various kind of ceiling mounted operating lamp.)

SHANGHAI HUIFENG MEDICAL INSTRUMENT CO.,LTD.

Add.No.7753,Chuannanfeng Highway,Datuan Town,Pudong New District,Shanghai Zip:201311

Sales department

Tel:0086-21-58082099, 58084992, 58085105, 58086595

Fax:0086-21-58085105

Http://www.huifeng-co.com